



imes-icore[®]
Dental & Medical Solutions



CORiTEC 250i Loader PRO

The features...



2-fold ionizer



Auto calibration



Automated
cleaning function



Adapter
variety



Metal processing

WITH FOCUS ON FLEXIBILITY,
THE CORiTEC 250i Loader **PRO**
SHOWS ITS STRENGTHS.



The fully automated 7-fold blank changer (9-fold optional) makes it possible to process multiple restorations successively without any delay. At the same time the system processes every restoration with the maximum precision. Thanks to the modular design of the blank changer it is also possible, to change the blank magazine with another new magazine easily.

The CORiTEC 250i Loader **PRO** is the perfect system for every dental technician who wants to work more independent. To support the idea of flexible working even more, the system comes with an integrated and fully-automated 16-fold tool changer. This feature saves a lot of time and grants the operator a maximum of flexibility. Just like the blank changer, the tool changer was also built modular. That means that it can also be easily and quickly exchanged with another tool magazine.

AUTOMATION IN THE SMALLEST SPACE -
NO OTHER SYSTEM IMPLEMENTS THIS
REQUIREMENT SO WELL.



Another highlight of the system is the powerful spindle. Thanks to a power of 750 watt and up to 100.000 rpm, the high-frequency spindle offers the best ratio of performance, speed and precision. A quality which can be felt with every restoration.

No matter which material will be used, the CORITEC 250i Loader **PRO** processes every restoration with the fastest speed and highest precision. Zirconium dioxide and plastics can be easily milled as well as the grinding of glass ceramics and prefabricated abutments of metal are possible. This system guarantees the operator a maximum of flexibility and automation for the main used dental materials.

ION

A
B

CORiTEC 250i Loader PRO

The compact 5-axis milling machine opens up a completely new machine segment at an attractive price-performance ratio. It offers automation and 5-axis simultaneous machining of circular blanks and blocks in the smallest space and. The milling system is equipped with a fully automatic 16-fold tool magazine with 3 mm milling tools and an integrated touch-screen monitor, which facilitates an intuitive operation in conjunction with the new SmartControl™ software. The fully automatic 7-fold (optional 9-fold) blank changer offers the possibility to process all common materials of the dental industry, an automated production is therefore feasible. The CORiTEC 250i Loader PRO is the perfect solution for technicians who want to create their daily work more independent!

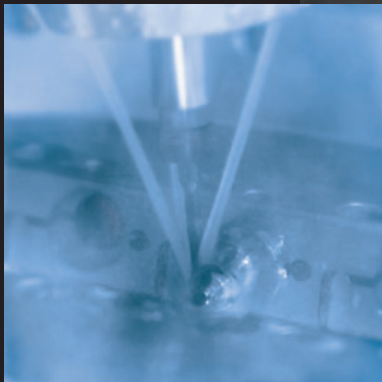

approx. 31.1 inch / 79 cm



WET

DRY

5 AX

3mm
16x

7x

ION

ION

ION

ION

ION

ION

ION

ION

ION

ION

ION

CORiTEC 250i Loader PRO

HIGHLIGHTS

- Novel, closed mono-block cast body for stability and precision
- 7-fold blank changer (optional 9-fold)
- 16-fold tool changer
- Blank and tool magazine exchangeable
- Wet and dry machining possible
- Control PC with touchscreen integrated
- 2-fold integrated ionizer
- Processing of prefabricated abutments
- High precision due to integrated temperature compensation
- High-frequency spindle
- Minimal footprint
- Auto calibration
- Automated cleaning function
- Metal processing

FULL AUTOMATION
7 or 9 blanks in one blank magazine, exchangeable

Optional: 9-fold blank magazine

7-fold blank magazine

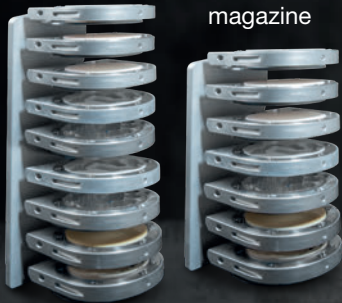

AUTOMATIC BLANK CLAMPING SYSTEM



POWERFUL PERFORMANCE
High-end spindle for milling and grinding up to 100.000 rpm at 750 Watt

16-FOLD TOOL CHANGER, TOOL MAGAZINE INTERCHANGEABLE



WET AND DRY MACHINING POSSIBLE

ERGONOMIC HANDLING
Control PC with touchscreen integrated

PMMA	WAX	Standard	PreMilled Abutment	Dentures	Crown, Bridge	Inlay, Onlay, Veneer	Hybrid Abutment	Splint
Zr	COMPOSITE							
PEEK	SINT	C-Clamp	Block	automatic clamping system	Full Denture	Model	Drilling template	Model casting
Glass ceramics	PreFab Abutments							
CoCr	Ti				Bridge	Telescopic technology	Abutment	Hybrid machining

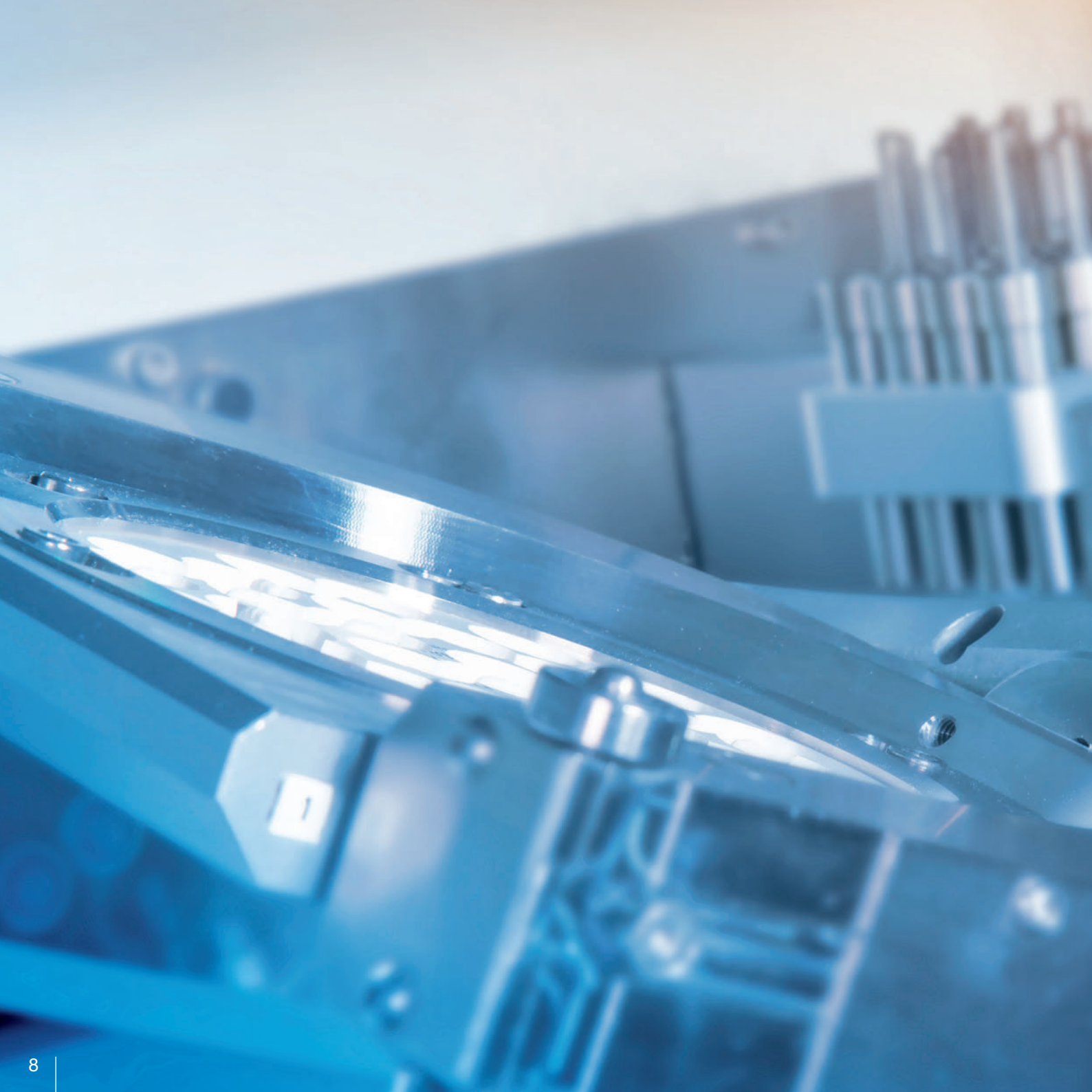

Applications & holder

MANUFACTURE OF DENTAL PROSTHESIS



PREFABRICATED ABUTMENTS

- Short production times
- Production of abutments in very simple processes
- High accuracy of fit due to prefabricated implant interface

DESS
Abutmentholder



NT-Preform® Abutment
(nt-trading)

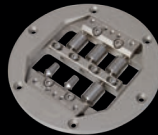

PreFace® Abutment
(Medentika)

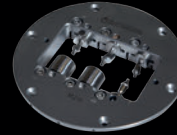

MED-Preform® Abutment
(medentis)

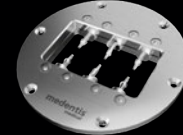

THERAPEUTIC SPLINTS

- Bite splints, bleaching splints
- Snoring splints, aligners
- Simple and high-quality implementation in CAD/CAM processes



GRINDING OF CAD/CAM BLOCKS

- New 6-fold adapter enables effective production
- Exchangeable strips for different adapter systems
- Crowns, onlays, inlays, veneers, bridge frameworks etc.



CORiTEC 250i Loader PRO TOOLS

T1/T6 - 3.0 | 3.0 mm
radius milling tool (l = 15 mm)

T1	Ti
T6	CoCr



3.0 mm Ø 3 mm

up to 15 mm ↑

Blades

Art.-No. 526029 3003

T11/T13 - 2.5 | 3.0 mm
radius milling tool

T11	PMMA
	WAX
T13	Zr



2.5 mm Ø 3 mm

up to 25 mm ↑

Blades

Art.-No. 526016 2503

T2/T7 - 2.0 | 3.0 mm
radius milling tool (l = 12 mm)

T2	Ti
T7	CoCr



2.0 mm Ø 3 mm

up to 15 mm ↑

Blades

Art.-No. 526029 2003

T12 - 1.0 | 3.0 mm
radius milling tool (single blade, slide coated)

T12	PMMA
	WAX
	PEEK



1.0 mm Ø 3 mm

up to 25 mm ↑

Blade

Art.-No. 526004 1003c

T3/T8 - 1.5 | 3.0 mm
radius milling tool (l = 12 mm)

T3	Ti
T8	CoCr



1.5 mm Ø 3 mm

up to 15 mm ↑

Blades

Art.-No. 526029 1503

T12/T14 - 1.0 | 3.0 mm
radius milling tool

T12	PMMA
	WAX
T14	Zr



1.0 mm Ø 3 mm

up to 25 mm ↑

Blades

Art.-No. 526016 1003

T4/T9 - 1.0 | 3.0 mm
radius milling tool (l = 9 mm)

T4	Ti
T9	CoCr



1.0 mm Ø 3 mm

up to 15 mm ↑

Blades

Art.-No. 526029 1003

T13/T40/T50 - 2.5 | 3.0 mm
radius milling tool (diamond coated)

T13	Zr
T40	SINT
T50	COMP



2.5 mm Ø 3 mm

up to 25 mm ↑

Blades

Art.-No. 526013 2503

T5/T10/T17 - 1.5 | 3.0 mm
shaft milling tool (l = 15 mm), universal

T5	Ti
T10	CoCr
	PMMA
	WAX
T17	Zr



1.5 mm Ø 3 mm

up to 25 mm ↑

Blades

Art.-No. 526001 1503

T14/T41/T51 - 1.0 | 3.0 mm
radius milling tool (diamond coated)

T14	Zr
T41	SINT
T51	COMP



1.0 mm Ø 3 mm

up to 25 mm ↑

Blades

Art.-No. 526013 1003

T11 - 2.5 | 3.0 mm
radius milling tool (single blade, slide coated)

T11	PMMA
	WAX
	PEEK



2.5 mm Ø 3 mm

up to 25 mm ↑

Blade

Art.-No. 526004 2503c

T15/T42/T52 - 0.6 | 3.0 mm
radius milling tool (conical)

T15	PMMA
	WAX
	Zr
T42	SINT
T52	COMP



0.6 mm Ø 3 mm

up to 25 mm ↑

Blades

Art.-No. 526016 0603

T16 - 1.5 | 3.0 mm
radius milling tool (l = 15 mm)

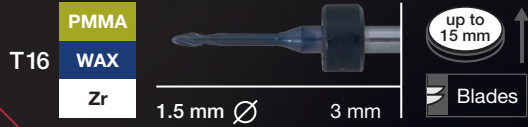

Art.-No. 526016 1503

T31 - 3.0 | 3.0 mm
shaft milling tool (single blade, slide coated)



Art.-No. 526012 3003

T19 - 0.5 | 3.0 mm
shaft milling tool (l = 4 mm), universal

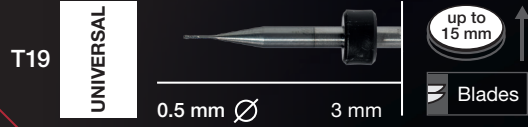

Art.-No. 526001 0503

T32 - 0.6 | 3.0 mm
radius milling tool long (l = 12 mm)

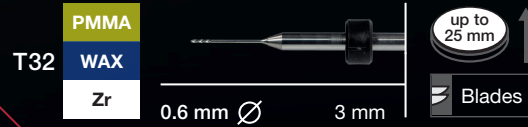

Art.-No. 526012 0603

T20 - 0.6 | 3.0 mm
radius milling tool (conical)

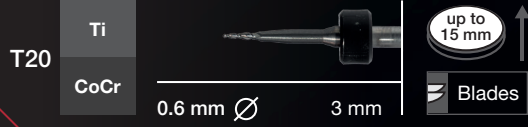

Art.-No. 526003 0603

T33/T43/T53 - 0.3 | 3.0 mm
radius milling tool (conical)



Art.-No. 526016 0303

T21 - 2.5 | 3.0 mm
radius grinding tool (diamond)



Art.-No. 526005 2503

T98 - 2.5 | 3.0 mm
shaft milling tool (l = 20 mm, three blades)

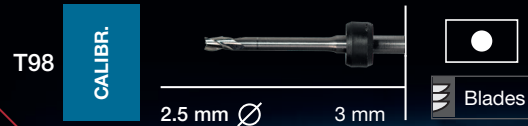

Art.-No. 526024 2503

T22 - 1.0 | 3.0 mm
radius grinding tool (diamond)

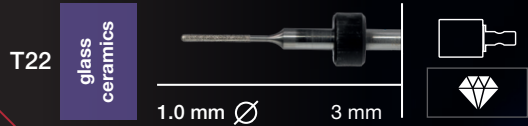

Art.-No. 526005 1003

T23 - 0.6 | 3.0 mm
radius grinding tool (conical, diamond)



Art.-No. 526005 0603

CORiTEC 250i Loader PRO TOOLS

CORiTEC Materials

CORiTEC ZR (ZIRCONIUM DIOXIDE)

Covers all indications for dental restorations of up to 16 units.
Ideally suited for monolithic restorations.

- Highly translucent zirconium dioxide for natural esthetics
- Increased strength compared to lithium dioxide

Zr ht+ Disc
(highly translucent)



Zr Disc



Zr transpa Disc



Zr transpa Disc
(pre-colored translucent)



CORiTEC COCR AND TITANIUM

- Single crowns
- Single cap
- Bridges up to 16 units, full bridges, and PFM technology
- Good mechanical properties
- Good milling properties
- Corrosion resistant

CoCr Disc
(non-precious alloy)



CoCr Mo Disc
(non-precious alloy)



Ti Disc
(Grad 2, Grad 4, Grad 5)



JUVORA PEEK

- Clamp-retained constructions
- Juvora PEEK in its basic colour (brown-beige)
- Highest biological compatibility



CORiTEC WAX DISC (WAX, GRAY)

CORiTEC Wax Disc is not suitable for intraoral application. After milling, the material can be used as lost wax. Moulds can be used in casting technology. It can be milled easily and combusted residue-free.



CORiTEC PMMA

- Bite guards, therapeutic splints, drilling templates, bite regulators
- Very good mechanical properties
- Aesthetic shade effect due to high translucency
- Good milling behaviour

PMMA Splint Disc



PMMA Disc



CORiTEC MODEL DISC IVORY

- Blank for the production of dental models
- Low-cost material
- Also suitable for test purposes or for milling calibration bodies



CORiTEC SmartControl™

SMART CONTROL OF MACHINE SOFTWARE

SmartControl™ one touch ahead!

The newly developed control software „SmartControl™“ enables absolutely intuitive operation of our milling machines. From selecting the job to milling or querying the machine status; the self-explanatory and optimized handling makes it possible to start operating the machine in the shortest possible time. Starting a milling process requires only two clicks – benefit from the smart time savings for your workflow!

FEATURES

- Modern touch control design
- Straightforward operation with intuitive graphical interface
- High end performance for imes-icore® machines
- Remote monitoring
- Job management with 3D preview
- Tool/material management
- Multi-language support*

optimized for touchscreen operation

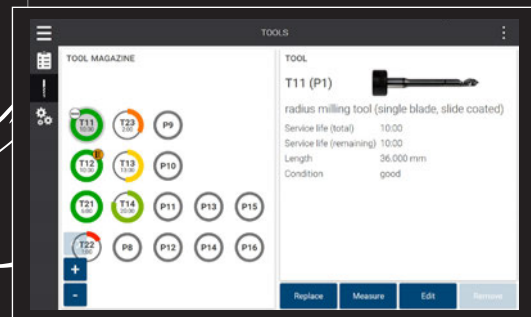

automated transfer of information from the CAM software

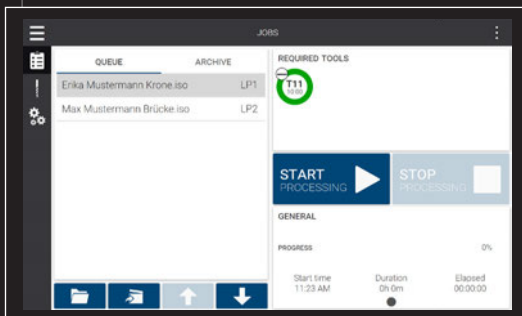

ideal tool management

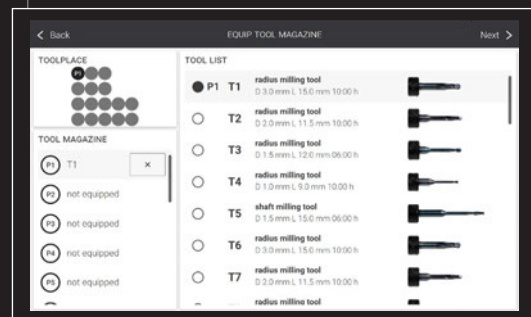

* in preparation

Scanner COMPATIBLE WITH **exocad**

CORiTEC i3Dscan eco

- All-round carefree package for newcomers or small laboratories
- Simple, fast, low-priced
- Very compact design



CORiTEC i3Dscan color

- The object to be scanned is automatically guided into the measuring field
- Modern touch control design
- The 180-degree opening offers a large working area



CORiTEC i3Dscan color HR

- Enormously high scanning efficiency and precision (4 µm)
- Color texture scan
- Blue-Light LED & high resolution camera (2.8 MP)
- All modules included in the scope of delivery

CAM Software

CORiTEC iCAM V5 smart

- All strategies optimized for 5-axis simultaneous machining
- Automatic exchange of implant connections (ReFit option)
- No annual license fees
- Fully automatic and easy operation with “Wizard Workflow“



CORiTEC iCAMHD

- hyperDENT based CAM software
- Flexible payment model (purchase or subscription model)
- Three months free use with CORiTEC 150i machine purchase

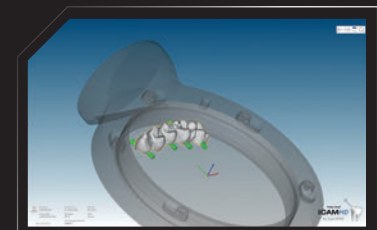

Machine tables

The undercounters, specially developed for the needs of the various machine types, impress with their sturdy design as well as their attractive appearance. The machine tables have sufficient floor space. Stable rollers ensure optimum stability and easy movement of the devices. Drawers, cable ducts and a cabinet for the integration of appropriate extraction systems are already provided.

Machine Table T2

41.7 x 36.6 x 31.1 inch
1060 x 930 x 790 mm
W x H x D



Suction systems

	iVAC silent PRO	iVAC eco+
Volume flow	240 m ³ /hr	260m ³ /hr
Output	1610 watt	1200 watt
Filter system	Teflon filter cartridge, automatic cleaning feature	dust drawer, HEPA filter
Filter volume	8 liters / 30.28 gpm	25 liters / 94.63 gpm
W x D x H	10.6 x 21.2 x 21.1 inch 270 x 540 x 535 mm	17.3 x 18.1 x 29.5 inch 440 x 460 x 750 mm
Supply voltage	115 V/230 V	115 V /230 V



Sintering Furnaces

iSINT eco

The iSINT eco stands for economy and offers high-quality technology, matching accessories for high standards at a fair price. Compact and with a small footprint, the iSINT eco sintering oven still has sufficient capacity for a sintering bowl Ø 100 mm for approx. 25 units. The door stop can be mounted at the right or left side.



iSINT PRO

A larger sintering capacity of up to 80 single crowns is offered by the new iSINT PRO. With a heating system of four high-quality molybdenum disilicide (MoSi₂) heating elements, you can choose between conventional long-term sintering or SPEED sintering at a rate of up to 99 °C/min/ 210.20 °F/min. The iSINT PRO is operated with a simple and convenient program control. The programs are indicated on a 4-line LCD display. A timer function for overnight sintering or the use of pre-drying programs for shaded zirconium restorations offer further options. In addition, three service programs are available for easy maintenance of the sinter furnace.



	iSINT eco	iSINT PRO
Number of heating elements	4	4
Display	7-Segment	4-line LCD
Number of program memories	9	30
Combustion chamber capacity	1 x 100	2 x 120
Max. heating rate	30 °C/min / 86 °F/min	99 °C/min / 210.20 °F/min
Power in Watt	1720	3200
Lift function	No	Yes
Speedsintering	No	Yes

Dimensions

CORiTEC 250i Loader PRO

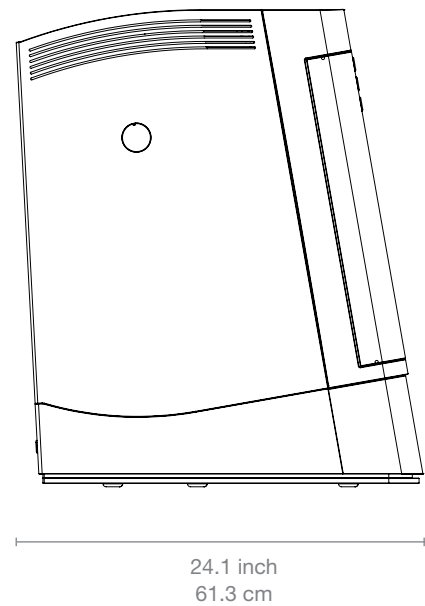
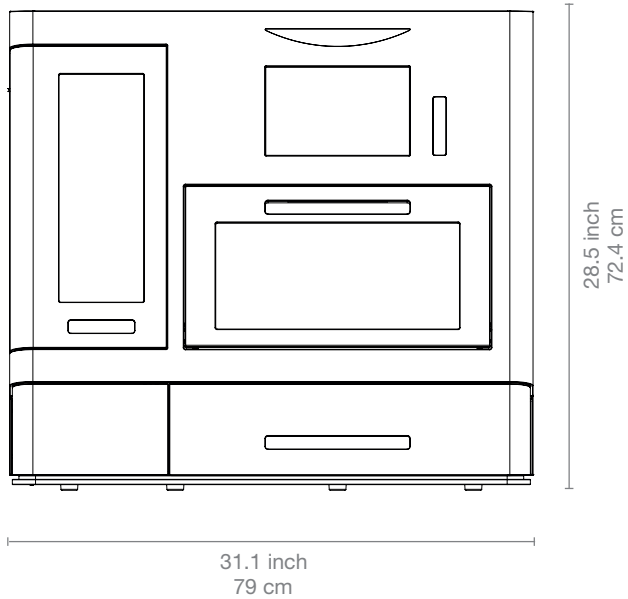

In Numbers

CORTEC 250i Loader PRO

Mechanics / electronics	
Basic construction	Mono cast body
Number of axes and operation type	5-axis, simultaneous machining
Rotation angle	A-axis 360° / B-axis up to ±30°
Spindle / power	High-frequency spindle / 750 watt
Maximum spindle speed	100.000 rpm
Blank changer	7-fold / 9-fold optional; magazine interchangeable
Tools	Milling and grinding tools with 3 mm shaft diameter
Tool changer integrated	16-fold, magazine interchangeable
Tool length control	≤ 0.002 mm precision
Integrated computer hardware	Windows based
Monitor	Control PC with 10.1" touchscreen integrated
Illumination	3 LED status colors
Software	SmartControl™
Air pressure	7 bar / 101.526 PSI constantly supply, 60 liters/min / 227.10 gpm/min
Cooling liquid	3.7 liter / 18.17 gpm integrated
Connecting requirements	
Weight	112 kg / 209.47 lbs
Width x depth x height	31.1 x 24.1 x 28.5 inch / 790 x 613 x 724 mm
Line voltage / frequency	100 V - 240 V / 50/60 Hz

Sales and support partner worldwide



Represented for you in over 100 countries.

imes-icore® GmbH has been a leading manufacturer and technology partner since 2003 in the field of dental CAD/CAM systems and solutions.

With its unique range of dental milling and grinding systems imes-icore® offers a perfect selection for all individual requirements of dental laboratories, milling centres and dental practices of all sizes.

Our “Open-System” product philosophy makes it possible to easily integrate our milling machines into your existing workflow and to integrate them with your open scanners and your CAD/CAM software. We are open for your material selection.

Dealer for the Netherlands:

www.ubervo.nl

uberVo
DENTAL B.V.